

مخازن
الإضاءة
LIGHTING STORES



www.illusillumination.com



LS AlMalaz



LS Takhasusi



LS Exit 5



LS Exit 9



LS Buraidah



LS Onaizah



LS Hail



LS AlKhaleej St.



LS AlFaaisaliyah



LS AlKhobar



LS Alemmarah 2 St.



LS AlDahran St.



LS Jeddah



LS AbHA



LS Khamies Mushait



LS Najran



LS Tabouk



LS AlJouf



Switches & Sockets
-Wiring Devices

مخازن
الإضاءة
LIGHTING STORES

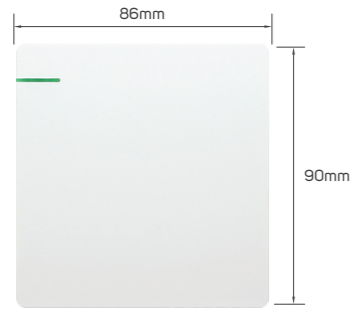

KD 0.800

Color	Item Code	Material	Body Colour	Module Colour	Current Capacity	Number of Gangs	Number of Ways	Poles
	532000	PC/red copper/AgCdO	white	white	16AX	1 gang	1 way	single
	532001	PC/red copper/AgCdO	gold	white	16AX	1 gang	1 way	single
	532002	PC/red copper/AgCdO	grey	white	16AX	1 gang	1 way	single
	532003	PC/red copper/AgCdO	black	white	16AX	1 gang	1 way	single

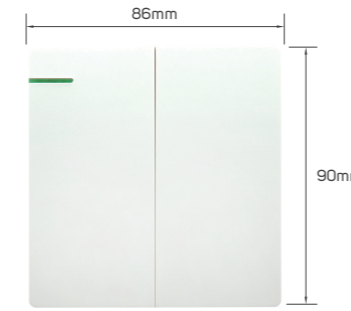

KD 2.600

Color	Item Code	Material	Body Colour	Module Colour	Current Capacity	Number of Gangs	Number of Ways	Poles
	532012	PC/red copper/AgCdO	white	white	16AX	2 gang	2 way	single
	532013	PC/red copper/AgCdO	gold	white	16AX	2 gang	2 way	single
	532014	PC/red copper/AgCdO	grey	white	16AX	2 gang	2 way	single
	532015	PC/red copper/AgCdO	black	white	16AX	2 gang	2 way	single

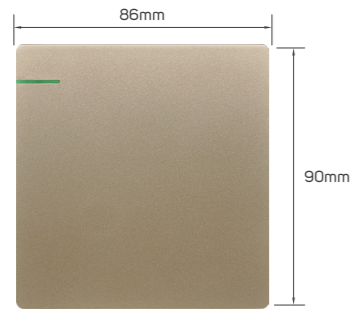

KD 0.950

Color	Item Code	Material	Body Colour	Module Colour	Current Capacity	Number of Gangs	Number of Ways	Poles
	532004	PC/red copper/AgCdO	white	white	16AX	1 gang	2 way	single
	532005	PC/red copper/AgCdO	gold	white	16AX	1 gang	2 way	single
	532006	PC/red copper/AgCdO	grey	white	16AX	1 gang	2 way	single
	532007	PC/red copper/AgCdO	black	white	16AX	1 gang	2 way	single

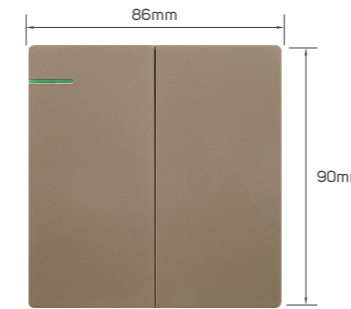

KD 1.150

Color	Item Code	Material	Body Colour	Module Colour	Current Capacity	Number of Gangs	Number of Ways	Poles
	532016	PC/red copper/AgCdO	white	white	16AX	2 gang	1 way	single
	532017	PC/red copper/AgCdO	gold	white	16AX	2 gang	1 way	single
	532018	PC/red copper/AgCdO	grey	white	16AX	2 gang	1 way	single
	532019	PC/red copper/AgCdO	black	white	16AX	2 gang	1 way	single

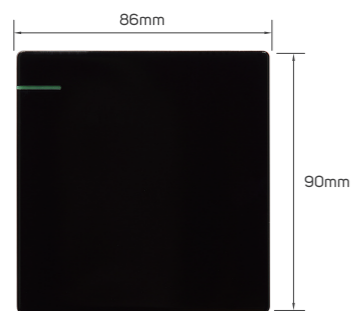

KD 1.650

Color	Item Code	Material	Body Colour	Module Colour	Current Capacity	Number of Gangs	Number of Ways	Poles
	532008	PC/red copper/AgCdO	white	white	16AX	1 gang	2 way	single
	532009	PC/red copper/AgCdO	gold	white	16AX	1 gang	2 way	single
	532010	PC/red copper/AgCdO	grey	white	16AX	1 gang	2 way	single
	532011	PC/red copper/AgCdO	black	white	16AX	1 gang	2 way	single

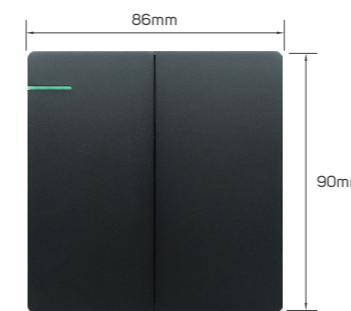

KD 1.450

Color	Item Code	Material	Body Colour	Module Colour	Current Capacity	Number of Gangs	Number of Ways	Poles
	532020	PC/red copper/AgCdO	white	white	16AX	2 gang	2 way	single
	532021	PC/red copper/AgCdO	gold	white	16AX	2 gang	2 way	single
	532022	PC/red copper/AgCdO	grey	white	16AX	2 gang	2 way	single
	532023	PC/red copper/AgCdO	black	white	16AX	2 gang	2 way	single

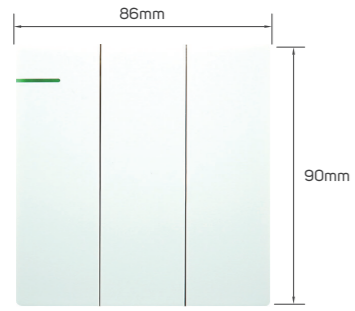

KD 1.700

Color	Item Code	Material	Body Colour	Module Colour	Current Capacity	Number of Gangs	Number of Ways	Poles
	532024	PC/red copper/AgCdO	white	white	16AX	3 gang	1 way	single
	532025	PC/red copper/AgCdO	gold	white	16AX	3 gang	1 way	single
	532026	PC/red copper/AgCdO	grey	white	16AX	3 gang	1 way	single
	532027	PC/red copper/AgCdO	black	white	16AX	3 gang	1 way	single

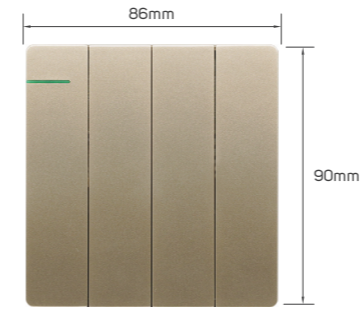

KD 2.850

Color	Item Code	Material	Body Colour	Module Colour	Current Capacity	Number of Gangs	Number of Ways	Poles
	532036	PC/red copper/AgCdO	white	white	16AX	4 gang	2 way	single
	532037	PC/red copper/AgCdO	gold	white	16AX	4 gang	2 way	single
	532038	PC/red copper/AgCdO	grey	white	16AX	4 gang	2 way	single
	532039	PC/red copper/AgCdO	black	white	16AX	4 gang	2 way	single

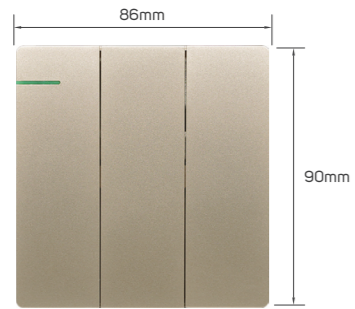

KD 2.100

Color	Item Code	Material	Body Colour	Module Colour	Current Capacity	Number of Gangs	Number of Ways	Poles
	532028	PC/red copper/AgCdO	white	white	16AX	3 gang	2 way	single
	532029	PC/red copper/AgCdO	gold	white	16AX	3 gang	2 way	single
	532030	PC/red copper/AgCdO	grey	white	16AX	3 gang	2 way	single
	532031	PC/red copper/AgCdO	black	white	16AX	3 gang	2 way	single

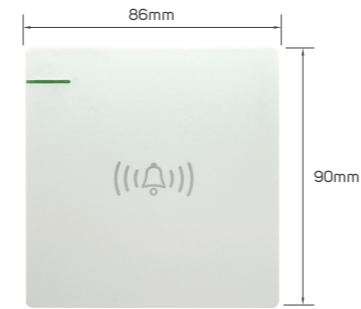

KD 1.010

Color	Item Code	Material	Body Colour	Module Colour	Current Capacity	Number of Gangs	Number of Ways	Poles
	532040	PC/red copper/AgCdO	white	white	16A	1 gang	1 way	single
	532041	PC/red copper/AgCdO	gold	white	16A	1 gang	1 way	single
	532042	PC/red copper/AgCdO	grey	white	16A	1 gang	1 way	single
	532043	PC/red copper/AgCdO	black	white	16A	1 gang	1 way	single

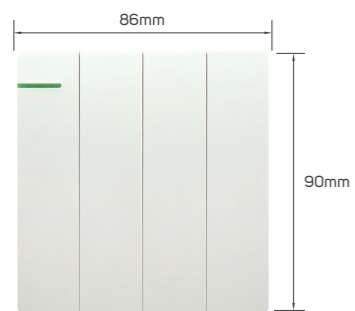

KD 2.250

Color	Item Code	Material	Body Colour	Module Colour	Current Capacity	Number of Gangs	Number of Ways	Poles
	532032	PC/red copper/AgCdO	white	white	16AX	4 gang	1 way	single
	532033	PC/red copper/AgCdO	gold	white	16AX	4 gang	1 way	single
	532034	PC/red copper/AgCdO	grey	white	16AX	4 gang	1 way	single
	532035	PC/red copper/AgCdO	black	white	16AX	4 gang	1 way	single

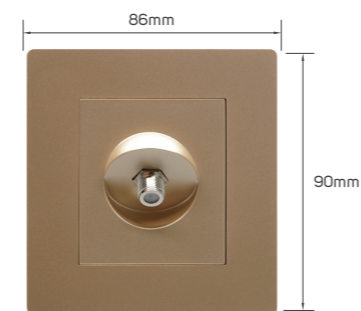

KD 1.400

Color	Item Code	Material	Body Colour	Module Colour	Current Capacity	Number of Gangs	Number of Ways	Poles
	532044	PC/Brass	white	white	/	/	/	/
	532045	PC/Brass	gold	white	/	/	/	/
	532046	PC/Brass	grey	white	/	/	/	/
	532047	PC/Brass	black	white	/	/	/	/

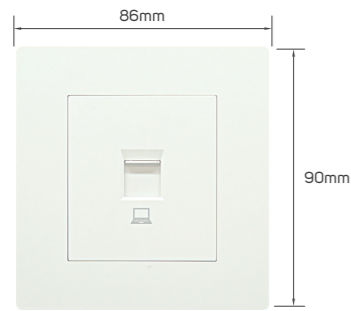

KD 2.010

Color	Item Code	Material	Body Colour	Module Colour	Current Capacity	Number of Gangs	Number of Ways	Poles
	532048	PC/Brass	white	white	/	/	/	/
	532049	PC/Brass	gold	white	/	/	/	/
	532050	PC/Brass	grey	white	/	/	/	/
	532051	PC/Brass	black	white	/	/	/	/

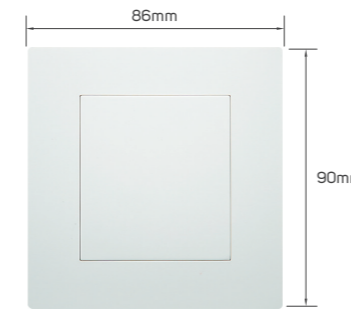

KD 0.600

Color	Item Code	Material	Body Colour	Module Colour	Current Capacity	Number of Gangs	Number of Ways	Poles
	532060	PC	white	white	/	/	/	/
	532061	PC	gold	white	/	/	/	/
	532062	PC	grey	white	/	/	/	/
	532063	PC	black	white	/	/	/	/

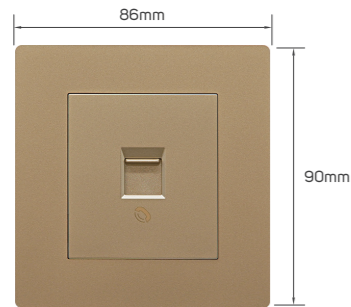

KD 1.550

Color	Item Code	Material	Body Colour	Module Colour	Current Capacity	Number of Gangs	Number of Ways	Poles
	532052	PC/Brass	white	white	/	/	/	/
	532053	PC/Brass	gold	white	/	/	/	/
	532054	PC/Brass	grey	white	/	/	/	/
	532055	PC/Brass	black	white	/	/	/	/

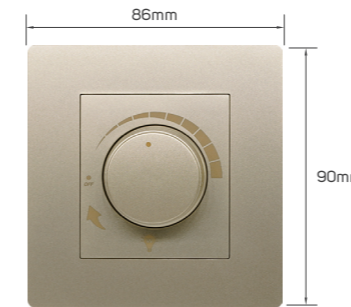

KD 5.650

Color	Item Code	Material	Body Colour	Module Colour	Current Capacity	Number of Gangs	Number of Ways	Poles
	532064	PC/PCB electrical parts	white	white	0.5A	/	/	L
	532065	PC/PCB electrical parts	gold	white	0.5A	/	/	L
	532066	PC/PCB electrical parts	grey	white	0.5A	/	/	L
	532067	PC/PCB electrical parts	black	white	0.5A	/	/	L

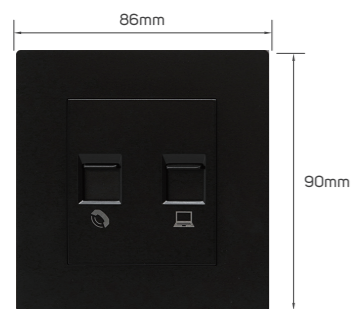

KD 2.650

Color	Item Code	Material	Body Colour	Module Colour	Current Capacity	Number of Gangs	Number of Ways	Poles
	532056	PC/Brass	white	white	/	/	/	/
	532057	PC/Brass	gold	white	/	/	/	/
	532058	PC/Brass	grey	white	/	/	/	/
	532059	PC/Brass	black	white	/	/	/	/



KD 2.850

Color	Item Code	Material	Body Colour	Module Colour	Current Capacity	Number of Gangs	Number of Ways	Poles
	532068	PC/Brass/AgCdO	white	white	32A	4 gang	1 way	double
	532069	PC/Brass/AgCdO	gold	white	32A	1 gang	1 way	double
	532070	PC/Brass/AgCdO	grey	white	32A	1 gang	1 way	double
	532071	PC/Brass/AgCdO	black	white	32A	1 gang	1 way	double

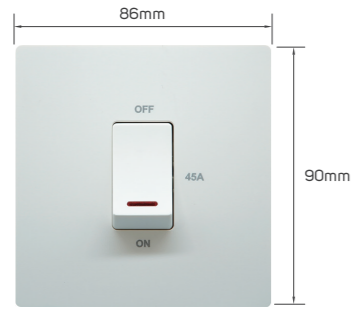

KD 3.400

Color	Item Code	Material	Body Colour	Module Colour	Current Capacity	Number of Gangs	Number of Ways	Poles
	532072	PC/Brass/AgCdO	white	white	45A	1 gang	1 way	double
	532073	PC/Brass/AgCdO	gold	white	45A	1 gang	1 way	double
	532074	PC/Brass/AgCdO	grey	white	45A	1 gang	1 way	double
	532075	PC/Brass/AgCdO	black	white	45A	1 gang	1 way	double

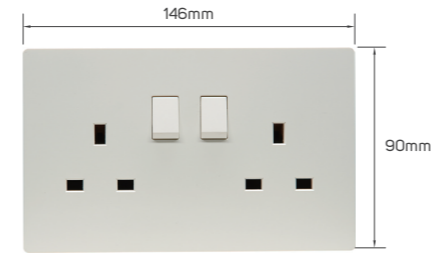

KD 3.800

Color	Item Code	Material	Body Colour	Module Colour	Current Capacity	Number of Gangs	Number of Ways	Poles
	532084	PC/Brass/phosphor bronze/AgCdO	white	white	13A	1 gang	1 way	double
	532085	PC/Brass/phosphor bronze/AgCdO	gold	white	13A	1 gang	1 way	double
	532086	PC/Brass/phosphor bronze/AgCdO	grey	white	13A	1 gang	1 way	double
	532087	PC/Brass/phosphor bronze/AgCdO	black	white	13A	1 gang	1 way	double

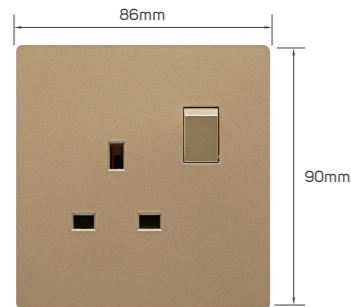

KD 1.950

Color	Item Code	Material	Body Colour	Module Colour	Current Capacity	Number of Gangs	Number of Ways	Poles
	532076	PC/Brass/phosphor bronze/AgCdO	white	white	13A	1 gang	1 way	double
	532077	PC/Brass/phosphor bronze/AgCdO	gold	white	13A	1 gang	1 way	double
	532078	PC/Brass/phosphor bronze/AgCdO	grey	white	13A	1 gang	1 way	double
	532079	PC/Brass/phosphor bronze/AgCdO	black	white	13A	1 gang	1 way	double

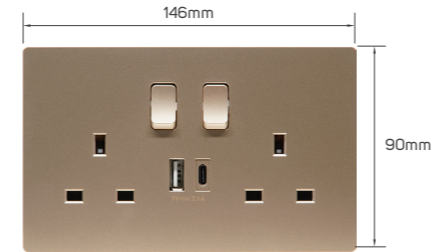

KD 8.800

Color	Item Code	Material	Body Colour	Module Colour	Current Capacity	Number of Gangs	Number of Ways	Poles
	532088	PC/Brass/phosphor bronze/AgCdO/PCB electrical parts	white	white	13A	1 gang	1 way	single
	532089	PC/Brass/phosphor bronze/AgCdO/PCB electrical parts	gold	white	13A	1 gang	1 way	single
	532090	PC/Brass/phosphor bronze/AgCdO/PCB electrical parts	grey	white	13A	1 gang	1 way	single
	532091	PC/Brass/phosphor bronze/AgCdO/PCB electrical parts	black	white	13A	1 gang	1 way	single

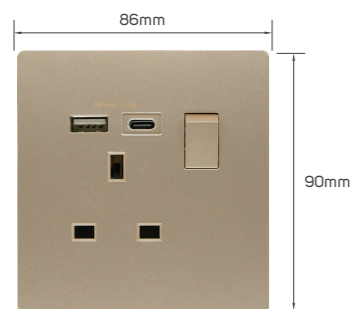

KD 6.850

Color	Item Code	Material	Body Colour	Module Colour	Current Capacity	Number of Gangs	Number of Ways	Poles
	532080	PC/Brass/phosphor bronze/AgCdO/PCB electrical parts	white	white	13A	1 gang	1 way	single
	532081	PC/Brass/phosphor bronze/AgCdO/PCB electrical parts	gold	white	13A	1 gang	1 way	single
	532082	PC/Brass/phosphor bronze/AgCdO/PCB electrical parts	grey	white	13A	1 gang	1 way	single
	532083	PC/Brass/phosphor bronze/AgCdO/PCB electrical parts	black	white	13A	1 gang	1 way	single

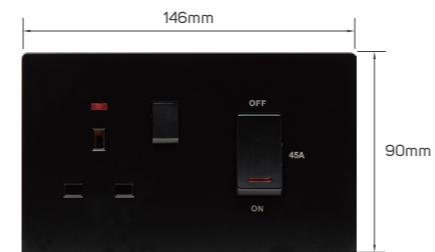

KD 4.700

Color	Item Code	Material	Body Colour	Module Colour	Current Capacity	Number of Gangs	Number of Ways	Poles
	532092	PC/Brass/phosphor bronze/AgCdO/PCB electrical parts	white	white	45A/13A	1 gang	1 way	double
	532093	PC/Brass/phosphor bronze/AgCdO/PCB electrical parts	gold	white	45A/13A	1 gang	1 way	double
	532094	PC/Brass/phosphor bronze/AgCdO/PCB electrical parts	grey	white	45A/13A	1 gang	1 way	double
	532095	PC/Brass/phosphor bronze/AgCdO/PCB electrical parts	black	white	45A/13A	1 gang	1 way	double

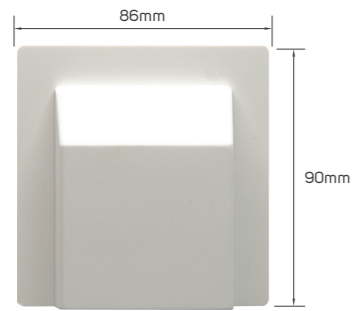

KD 3.150

Color	Item Code	Material	Body Colour	Module Colour	Current Capacity	Number of Gangs	Number of Ways	Poles
	532096	PC/Brass	white	white	45A	/	/	/
	532097	PC/Brass	gold	white	45A	/	/	/
	532098	PC/Brass	grey	white	45A	/	/	/
	532099	PC/Brass	black	white	45A	/	/	/

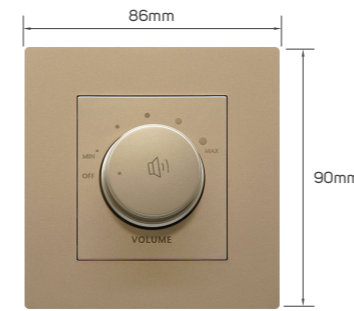

KD 6.150

Color	Item Code	Material	Body Colour	Module Colour	Current Capacity	Number of Gangs	Number of Ways	Poles
	532108	PC/PCB electrical parts	white	white	/	/	/	L
	532109	PC/PCB electrical parts	gold	white	/	/	/	L
	532110	PC/PCB electrical parts	grey	white	/	/	/	L
	532111	PC/PCB electrical parts	black	white	/	/	/	L



KD 4.450

Color	Item Code	Material	Body Colour	Module Colour	Current Capacity	Number of Gangs	Number of Ways	Poles
	532100	PC/PCB electrical parts	white	white	1.3A	/	/	L
	532101	PC/PCB electrical parts	gold	white	1.3A	/	/	L
	532102	PC/PCB electrical parts	grey	white	1.3A	/	/	L
	532103	PC/PCB electrical parts	black	white	1.3A	/	/	L

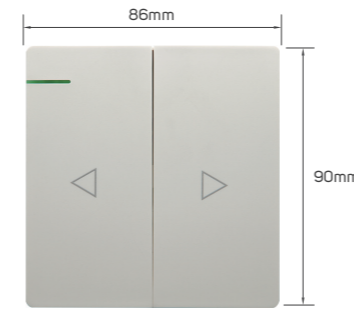

KD 2.200

Color	Item Code	Material	Body Colour	Module Colour	Current Capacity	Number of Gangs	Number of Ways	Poles
	532112	PC/red copper/AgCdO	white	white	16AX	2 gang	1 way	single
	532113	PC/red copper/AgCdO	gold	white	16AX	2 gang	1 way	single
	532114	PC/red copper/AgCdO	grey	white	16AX	2 gang	1 way	single
	532115	PC/red copper/AgCdO	black	white	16AX	2 gang	1 way	single

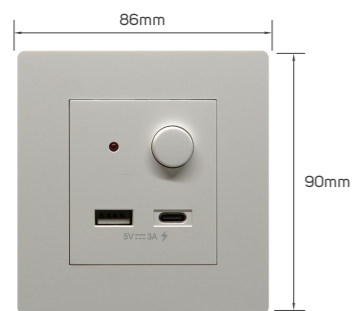

KD 5.250

Color	Item Code	Material	Body Colour	Module Colour	Current Capacity	Number of Gangs	Number of Ways	Poles
	532104	PC/PCB electrical parts	white	white	3.1A	/	/	L
	532105	PC/PCB electrical parts	gold	white	3.1A	/	/	L
	532106	PC/PCB electrical parts	grey	white	3.1A	/	/	L
	532107	PC/PCB electrical parts	black	white	3.1A	/	/	L



KD 3.650

Color	Item Code	Material	Body Colour	Module Colour	Current Capacity	Number of Gangs	Number of Ways	Poles
	532116	PC/PA	white	white	/	/	/	L, N
	532117	PC/PA	gold	white	/	/	/	L, N
	532118	PC/PA	grey	white	/	/	/	L, N
	532119	PC/PA	black	white	/	/	/	L, N

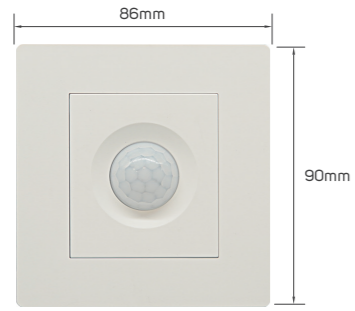

KD 5.000

Color	Item Code	Material	Body Colour	Module Colour	Current Capacity	Number of Gangs	Number of Ways	Poles
	532120	PC/PCB electrical parts	white	white	0.5A	/	/	L, N
	532121	PC/PCB electrical parts	gold	white	0.5A	/	/	L, N
	532122	PC/PCB electrical parts	grey	white	0.5A	/	/	L, N
	532123	PC/PCB electrical parts	black	white	0.5A	/	/	L, N

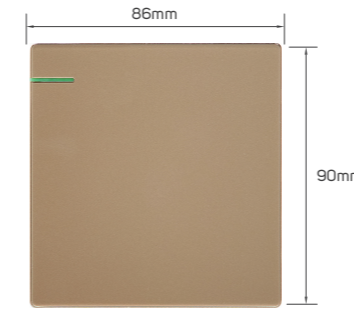

KD 1.150

Color	Item Code	Material	Body Colour	Module Colour	Current Capacity	Number of Gangs	Number of Ways	Poles
	532129	PC/red copper/AgCdO	grey	white	16AX	1 gang	1 way	single
	532130	PC/red copper/AgCdO	gold	white	16AX	1 gang	1 way	single
	532131	PC/red copper/AgCdO	black	white	16AX	1 gang	1 way	single

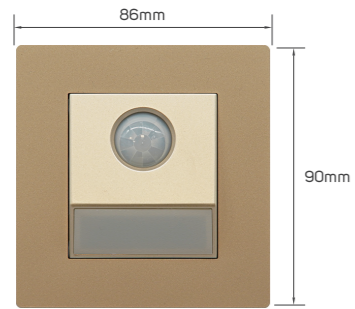

KD 6.050

Color	Item Code	Material	Body Colour	Module Colour	Current Capacity	Number of Gangs	Number of Ways	Poles
	532124	PC/PCB electrical parts	white	white	0.005A	/	/	L, N
	532125	PC/PCB electrical parts	gold	white	0.005A	/	/	L, N
	532126	PC/PCB electrical parts	grey	white	0.005A	/	/	L, N
	532127	PC/PCB electrical parts	black	white	0.005A	/	/	L, N

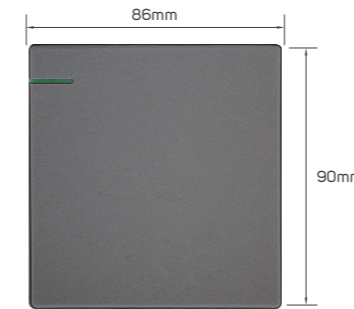

KD 1.400

Color	Item Code	Material	Body Colour	Module Colour	Current Capacity	Number of Gangs	Number of Ways	Poles
	532132	PC/red copper/AgCdO	grey	white	16AX	1 gang	2 way	single
	532133	PC/red copper/AgCdO	gold	white	16AX	1 gang	2 way	single
	532134	PC/red copper/AgCdO	black	white	16AX	1 gang	2 way	single

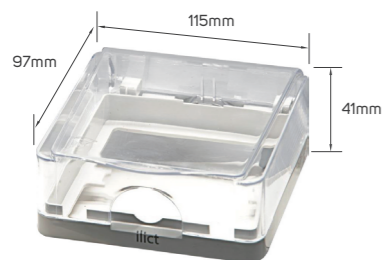

KD 0.750

Color	Item Code	Material	Body Colour	Module Colour	Current Capacity	Number of Gangs	Number of Ways	Poles
	532128	/	Blue	/	/	/	/	/

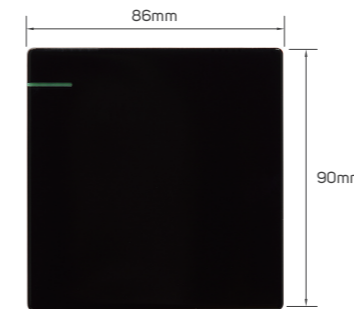

KD 2.450

Color	Item Code	Material	Body Colour	Module Colour	Current Capacity	Number of Gangs	Number of Ways	Poles
	532135	PC/red copper/AgCdO	grey	white	16AX	1 gang	2 way	single
	532136	PC/red copper/AgCdO	gold	white	16AX	1 gang	2 way	single
	532137	PC/red copper/AgCdO	black	white	16AX	1 gang	2 way	single

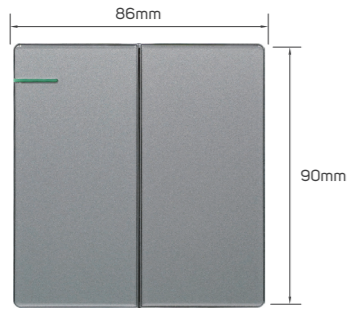

KD 4.450

Color	Item Code	Material	Body Colour	Module Colour	Current Capacity	Number of Gangs	Number of Ways	Poles
	532138	PC/red copper/AgCdO	grey	white	16AX	2 gang	2 way	single
	532139	PC/red copper/AgCdO	gold	white	16AX	2 gang	2 way	single
	532140	PC/red copper/AgCdO	black	white	16AX	2 gang	2 way	single

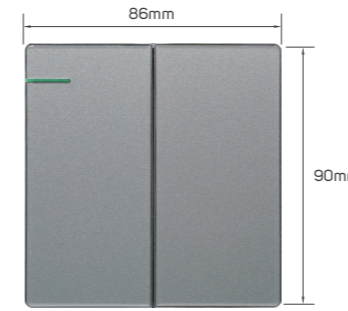

KD 1.950

Color	Item Code	Material	Body Colour	Module Colour	Current Capacity	Number of Gangs	Number of Ways	Poles
	532147	PC/red copper/AgCdO	grey	white	16AX	2 gang	2 way	single
	532148	PC/red copper/AgCdO	gold	white	16AX	2 gang	2 way	single
	532149	PC/red copper/AgCdO	black	white	16AX	2 gang	2 way	single

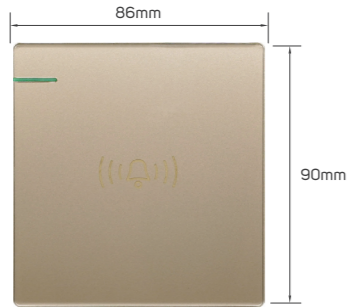

KD 1.550

Color	Item Code	Material	Body Colour	Module Colour	Current Capacity	Number of Gangs	Number of Ways	Poles
	532141	PC/red copper/AgCdO	grey	white	16A	1 gang	1 way	single
	532142	PC/red copper/AgCdO	gold	white	16A	1 gang	1 way	single
	532143	PC/red copper/AgCdO	black	white	16A	1 gang	1 way	single

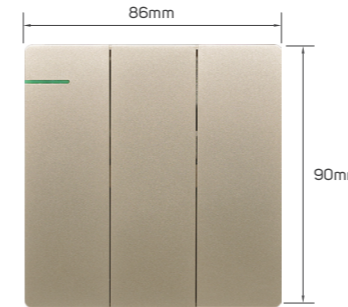

KD 2.200

Color	Item Code	Material	Body Colour	Module Colour	Current Capacity	Number of Gangs	Number of Ways	Poles
	532150	PC/red copper/AgCdO	grey	white	16AX	3 gang	1 way	single
	532151	PC/red copper/AgCdO	gold	white	16AX	3 gang	1 way	single
	532152	PC/red copper/AgCdO	black	white	16AX	3 gang	1 way	single

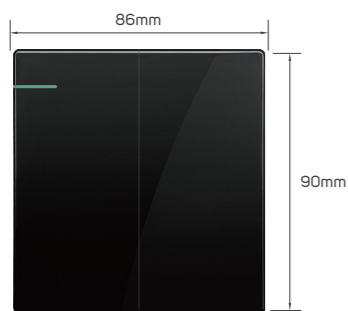

KD 1.550

Color	Item Code	Material	Body Colour	Module Colour	Current Capacity	Number of Gangs	Number of Ways	Poles
	532144	PC/red copper/AgCdO	grey	white	16AX	2 gang	1 way	single
	532145	PC/red copper/AgCdO	gold	white	16AX	2 gang	1 way	single
	532146	PC/red copper/AgCdO	black	white	16AX	2 gang	1 way	single

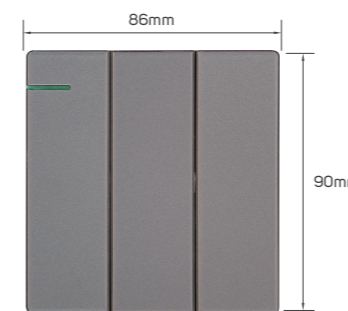

KD 2.600

Color	Item Code	Material	Body Colour	Module Colour	Current Capacity	Number of Gangs	Number of Ways	Poles
	532153	PC/red copper/AgCdO	grey	white	16AX	3 gang	2 way	single
	532154	PC/red copper/AgCdO	gold	white	16AX	3 gang	2 way	single
	532155	PC/red copper/AgCdO	black	white	16AX	3 gang	2 way	single

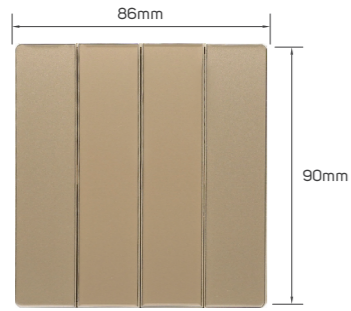

KD 2.750

Color	Item Code	Material	Body Colour	Module Colour	Current Capacity	Number of Gangs	Number of Ways	Poles
	532156	PC/red copper/AgCdO	grey	white	16AX	4 gang	1 way	single
	532157	PC/red copper/AgCdO	gold	white	16AX	4 gang	1 way	single
	532158	PC/red copper/AgCdO	black	white	16AX	4 gang	1 way	single

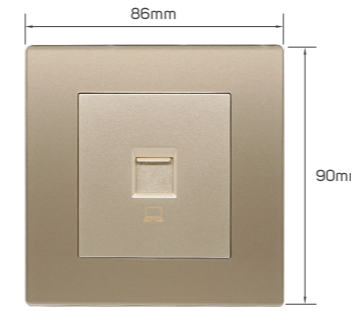

KD 2.600

Color	Item Code	Material	Body Colour	Module Colour	Current Capacity	Number of Gangs	Number of Ways	Poles
	532165	PC/Brass	grey	white	/	/	/	/
	532166	PC/Brass	gold	white	/	/	/	/
	532167	PC/Brass	black	white	/	/	/	/

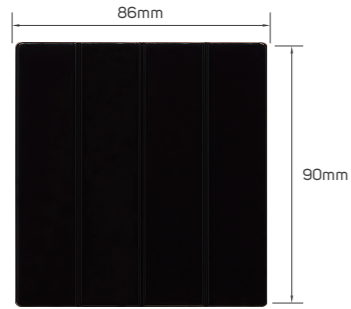

KD 3.250

Color	Item Code	Material	Body Colour	Module Colour	Current Capacity	Number of Gangs	Number of Ways	Poles
	532159	PC/red copper/AgCdO	grey	white	16AX	4 gang	2 way	single
	532160	PC/red copper/AgCdO	gold	white	16AX	4 gang	2 way	single
	532161	PC/red copper/AgCdO	black	white	16AX	4 gang	2 way	single

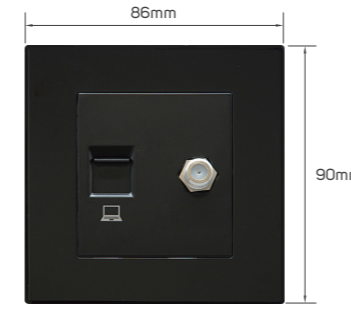

KD 2.200

Color	Item Code	Material	Body Colour	Module Colour	Current Capacity	Number of Gangs	Number of Ways	Poles
	532168	PC/Brass	grey	white	/	/	/	/
	532169	PC/Brass	gold	white	/	/	/	/
	532170	PC/Brass	black	white	/	/	/	/

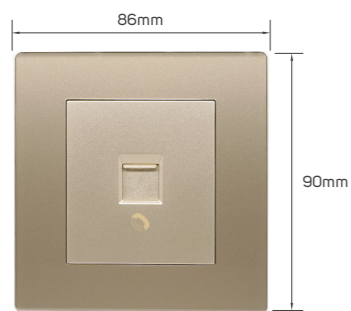

KD 2.100

Color	Item Code	Material	Body Colour	Module Colour	Current Capacity	Number of Gangs	Number of Ways	Poles
	532162	PC/Brass	grey	white	/	/	/	/
	532163	PC/Brass	gold	white	/	/	/	/
	532164	PC/Brass	black	white	/	/	/	/

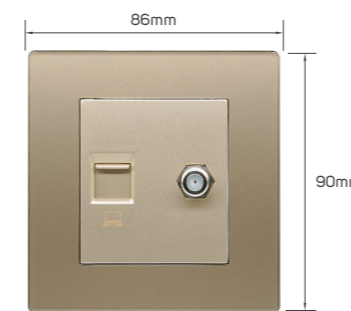

KD 3.150

Color	Item Code	Material	Body Colour	Module Colour	Current Capacity	Number of Gangs	Number of Ways	Poles
	532171	PC/Brass	grey	white	/	/	/	/
	532172	PC/Brass	gold	white	/	/	/	/
	532173	PC/Brass	black	white	/	/	/	/

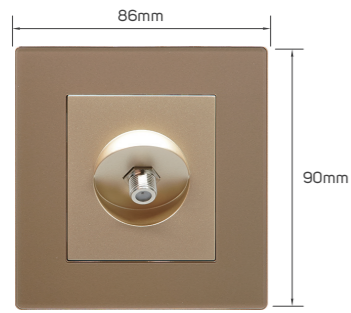

KD 2.000

Color	Item Code	Material	Body Colour	Module Colour	Current Capacity	Number of Gangs	Number of Ways	Poles
	532174	PC/Brass	grey	white	/	/	/	/
	532175	PC/Brass	gold	white	/	/	/	/
	532176	PC/Brass	black	white	/	/	/	/

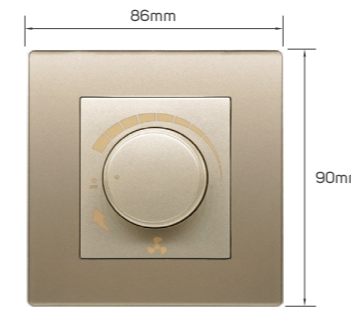

KD 5.250

Color	Item Code	Material	Body Colour	Module Colour	Current Capacity	Number of Gangs	Number of Ways	Poles
	532183	PC/PCB electrical parts	grey	white	1.3A	/	/	L
	532184	PC/PCB electrical parts	gold	white	1.3A	/	/	L
	532185	PC/PCB electrical parts	black	white	1.3A	/	/	L



KD 6.100

Color	Item Code	Material	Body Colour	Module Colour	Current Capacity	Number of Gangs	Number of Ways	Poles
	532177	PC/PCB electrical parts	grey	white	3.1A	/	/	L
	532178	PC/PCB electrical parts	gold	white	3.1A	/	/	L
	532179	PC/PCB electrical parts	black	white	3.1A	/	/	L

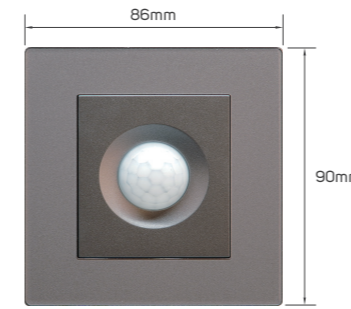

KD 5.250

Color	Item Code	Material	Body Colour	Module Colour	Current Capacity	Number of Gangs	Number of Ways	Poles
	532186	PC/PCB electrical parts	grey	white	0.5A	/	/	L, N
	532187	PC/PCB electrical parts	gold	white	0.5A	/	/	L, N
	532188	PC/PCB electrical parts	black	white	0.5A	/	/	L, N

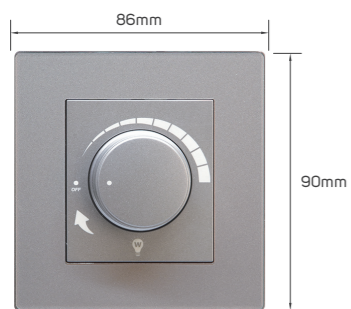

KD 5.250

Color	Item Code	Material	Body Colour	Module Colour	Current Capacity	Number of Gangs	Number of Ways	Poles
	532180	PC/PCB electrical parts	grey	white	0.5A	/	/	L
	532181	PC/PCB electrical parts	gold	white	0.5A	/	/	L
	532182	PC/PCB electrical parts	black	white	0.5A	/	/	L

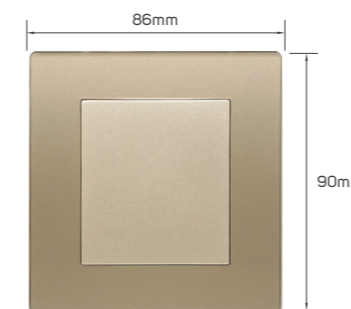

KD 0.800

Color	Item Code	Material	Body Colour	Module Colour	Current Capacity	Number of Gangs	Number of Ways	Poles
	532189	PC	grey	white	/	/	/	/
	532190	PC	gold	white	/	/	/	/
	532191	PC	black	white	/	/	/	/



KD 2.650

Color	Item Code	Material	Body Colour	Module Colour	Current Capacity	Number of Gangs	Number of Ways	Poles
	532192	PC/Brass/AgCdO	grey	white	32A	4 gang	1 way	double
	532193	PC/Brass/AgCdO	gold	white	32A	1 gang	1 way	double
	532194	PC/Brass/AgCdO	black	white	32A	1 gang	1 way	double

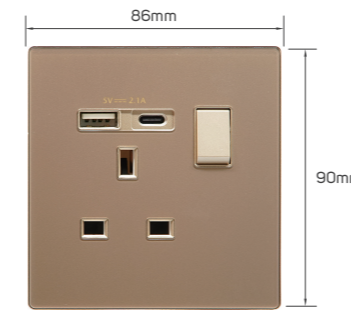

KD 7.800

Color	Item Code	Material	Body Colour	Module Colour	Current Capacity	Number of Gangs	Number of Ways	Poles
	532201	PC/Brass/phosphor bronze/AgCdO/PCB electrical parts	grey	white	13A	1 gang	1 way	single
	532202	PC/Brass/phosphor bronze/AgCdO/PCB electrical parts	gold	white	13A	1 gang	1 way	single
	532203	PC/Brass/phosphor bronze/AgCdO/PCB electrical parts	black	white	13A	1 gang	1 way	single

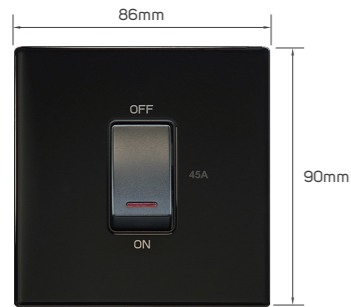

KD 3.400

Color	Item Code	Material	Body Colour	Module Colour	Current Capacity	Number of Gangs	Number of Ways	Poles
	532195	PC/Brass/AgCdO	grey	white	45A	1 gang	1 way	double
	532196	PC/Brass/AgCdO	gold	white	45A	1 gang	1 way	double
	532197	PC/Brass/AgCdO	black	white	45A	1 gang	1 way	double

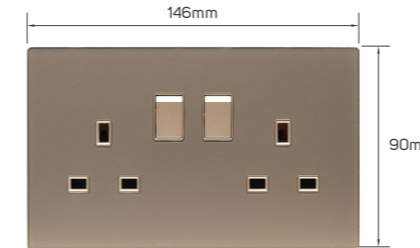

KD 4.350

Color	Item Code	Material	Body Colour	Module Colour	Current Capacity	Number of Gangs	Number of Ways	Poles
	532204	PC/Brass/phosphor bronze/AgCdO	grey	white	13A	1 gang	1 way	double
	532205	PC/Brass/phosphor bronze/AgCdO	gold	white	13A	1 gang	1 way	double
	532206	PC/Brass/phosphor bronze/AgCdO	black	white	13A	1 gang	1 way	double

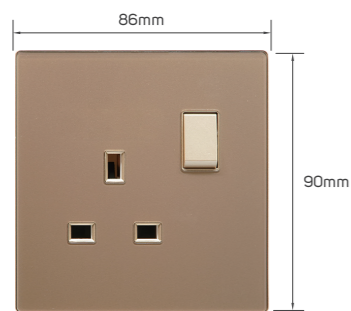

KD 2.250

Color	Item Code	Material	Body Colour	Module Colour	Current Capacity	Number of Gangs	Number of Ways	Poles
	532198	PC/Brass/phosphor bronze/AgCdO	grey	white	13A	1 gang	1 way	double
	532199	PC/Brass/phosphor bronze/AgCdO	gold	white	13A	1 gang	1 way	double
	532200	PC/Brass/phosphor bronze/AgCdO	black	white	13A	1 gang	1 way	double

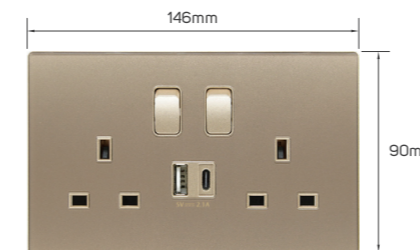

KD 9.900

Color	Item Code	Material	Body Colour	Module Colour	Current Capacity	Number of Gangs	Number of Ways	Poles
	532207	PC/Brass/phosphor bronze/AgCdO/PCB electrical parts	grey	white	13A	1 gang	1 way	single
	532208	PC/Brass/phosphor bronze/AgCdO/PCB electrical parts	gold	white	13A	1 gang	1 way	single
	532209	PC/Brass/phosphor bronze/AgCdO/PCB electrical parts	black	white	13A	1 gang	1 way	single

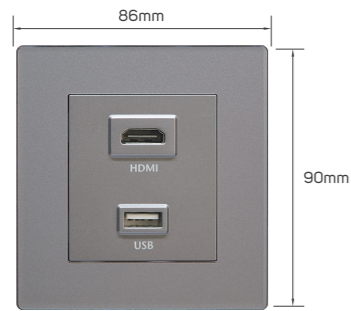

KD 4.350

Color	Item Code	Material	Body Colour	Module Colour	Current Capacity	Number of Gangs	Number of Ways	Poles
	532210	PC/PA	grey	white	/	/	/	L, N
	532211	PC/PA	gold	white	/	/	/	L, N
	532212	PC/PA	black	white	/	/	/	L, N

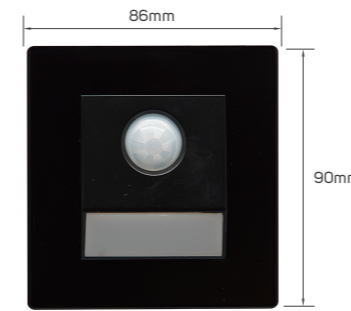

KD 6.850

Color	Item Code	Material	Body Colour	Module Colour	Current Capacity	Number of Gangs	Number of Ways	Poles
	532219	PC/PCB electrical parts	grey	white	0.005A	/	/	L, N
	532220	PC/PCB electrical parts	gold	white	0.005A	/	/	L, N
	532221	PC/PCB electrical parts	black	white	0.005A	/	/	L, N



KD 5.500

Color	Item Code	Material	Body Colour	Module Colour	Current Capacity	Number of Gangs	Number of Ways	Poles
	532213	PC/Brass/phosphor bronze/AgCdO/PCB electrical parts	grey	white	45A/13A	1 gang	1 way	double
	532214	PC/Brass/phosphor bronze/AgCdO/PCB electrical parts	gold	white	45A/13A	1 gang	1 way	double
	532215	PC/Brass/phosphor bronze/AgCdO/PCB electrical parts	black	white	45A/13A	1 gang	1 way	double

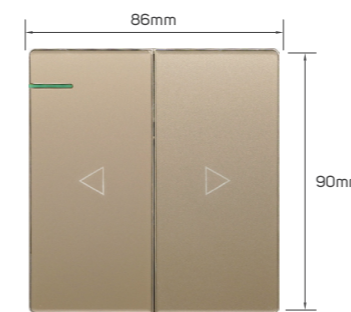

KD 2.750

Color	Item Code	Material	Body Colour	Module Colour	Current Capacity	Number of Gangs	Number of Ways	Poles
	532222	PC/red copper/AgCdO	grey	white	16AX	2 gang	1 way	single
	532223	PC/red copper/AgCdO	gold	white	16AX	2 gang	1 way	single
	532224	PC/red copper/AgCdO	black	white	16AX	2 gang	1 way	single



KD 6.950

Color	Item Code	Material	Body Colour	Module Colour	Current Capacity	Number of Gangs	Number of Ways	Poles
	532216	PC/PCB electrical parts	grey	white	/	/	/	L
	532217	PC/PCB electrical parts	gold	white	/	/	/	L
	532218	PC/PCB electrical parts	black	white	/	/	/	L

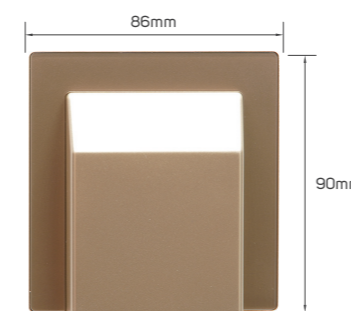

KD 3.150

Color	Item Code	Material	Body Colour	Module Colour	Current Capacity	Number of Gangs	Number of Ways	Poles
	532225	PC/Brass	grey	white	45A	/	/	/
	532226	PC/Brass	gold	white	45A	/	/	/
	532227	PC/Brass	black	white	45A	/	/	/

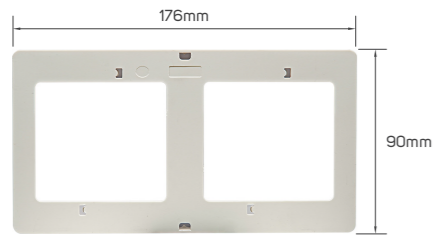

KD 0.850

Color	Item Code	Material	Body Colour	Module Colour	Current Capacity	Number of Gangs	Number of Ways	Poles
○	532228	/	white	/	/	/	/	/
●	532229	/	gold	/	/	/	/	/
●	532230	/	grey	/	/	/	/	/
●	532231	/	black	/	/	/	/	/

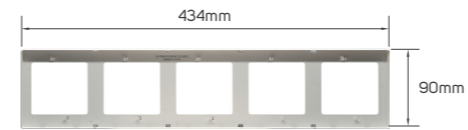

KD 1.550

Color	Item Code	Material	Body Colour	Module Colour	Current Capacity	Number of Gangs	Number of Ways	Poles
○	532240	/	white	/	/	/	/	/
●	532241	/	gold	/	/	/	/	/
●	532242	/	grey	/	/	/	/	/
●	532243	/	black	/	/	/	/	/

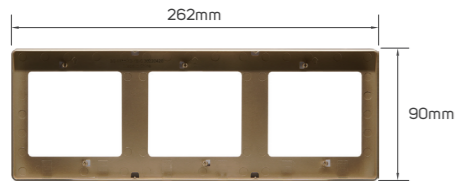

KD 1.000

Color	Item Code	Material	Body Colour	Module Colour	Current Capacity	Number of Gangs	Number of Ways	Poles
○	532232	/	white	/	/	/	/	/
●	532233	/	gold	/	/	/	/	/
●	532234	/	grey	/	/	/	/	/
●	532235	/	black	/	/	/	/	/

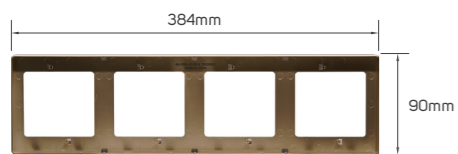

KD 1.250

Color	Item Code	Material	Body Colour	Module Colour	Current Capacity	Number of Gangs	Number of Ways	Poles
○	532236	/	white	/	/	/	/	/
●	532237	/	gold	/	/	/	/	/
●	532238	/	grey	/	/	/	/	/
●	532239	/	black	/	/	/	/	/